

## SHADE COMPONENTS

### *TUBES*

#### ***1.5" Aluminum Tube***

Used with M16 Manual Clutch Systems for smaller shades the 1.5" tube is made of T6 aluminum and has a 0.063" wall thickness. Two spline openings are built in for fabric attachment.

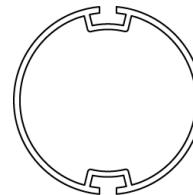

---

#### ***1.75" Aluminum Tube***

Used with M24 Manual Clutch Systems for medium to large shades the 1.75" tube is made of T6 aluminum and has a 0.055" wall thickness. Three spline openings are built in for fabric attachment. This tube can be used with the Spring Assisted Clutch Mechanism.

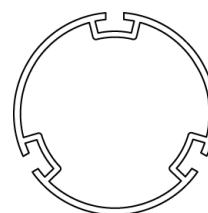

---

#### ***2½" Aluminum Tube***

Used with both the M24 Manual Clutch Systems for large to very large shades and also for standard Motorized Shade Systems the 2.5" tube is made of T6 aluminum and has a 0.082" wall thickness. Three spline openings are built in for fabric attachment. For manual shades, this tube can be used with the Spring Assisted Clutch Mechanism.

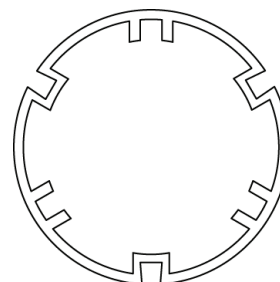

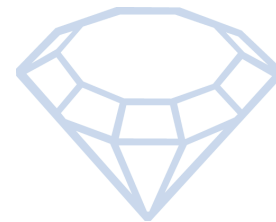

## SHADE COMPONENTS

### FASCIA

#### 3" Square Fascia

- A snap on aluminum fascia panel that covers the shade roll and mounting hardware. It provides a sleek finished look. 3" box brackets mount to side, ceiling, or rear wall.
- 3" Square Fascia is for M16 Manual Shades.
- Colors: White, Bone, Bronze, Black and Clear Anodized. Custom colors available at an additional charge.

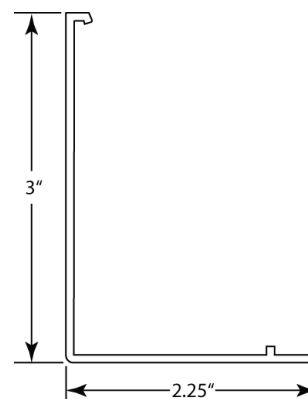

---

#### 3" Round Fascia

- A snap on aluminum fascia panel that covers the shade roll and mounting hardware. It provides a sleek finished look. 3" box brackets mount to side, ceiling, or rear wall.
- 3" Round Fascia is for M16 Manual Shades.
- Round Fascia can be ordered covered with fabric to match shade material.
- Colors: White, Bone, Bronze, Black and Clear Anodized. Custom colors available at an additional charge.

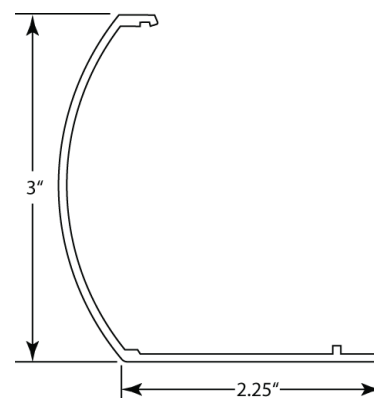

---

#### 4" Square Fascia

- A snap on aluminum fascia panel that covers the shade roll and mounting hardware. It provides a sleek finished look. 4" box brackets mount to side, ceiling, or rear wall.
- Designed for larger shades and thicker tube diameters, the 4" Square Fascia is for M24 Manual Shades.
- Colors: White, Bone, Bronze, Black and Clear Anodized. Custom colors available at an additional charge.

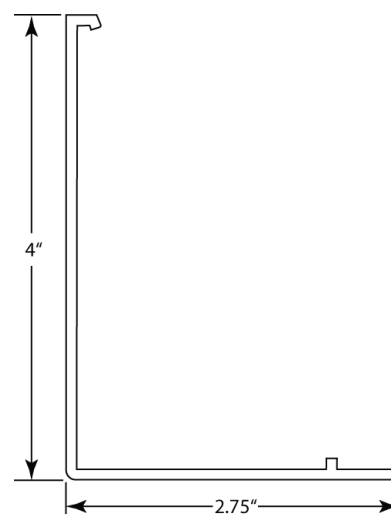

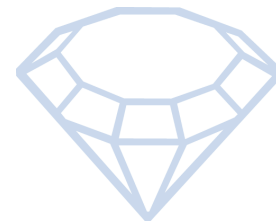

## SHADE COMPONENTS

### FASCIA

#### 4" Round Fascia

- A snap on aluminum fascia panel that covers the shade roll and mounting hardware. It provides a sleek finished look. 4" box brackets mount to side, ceiling, or rear wall.
- Designed for larger shades and thicker tube diameters, the 4" Round Fascia is for M16 Manual Shades.
- Round Fascia can be ordered covered with fabric to match shade material.
- Colors: White, Bone, Bronze, Black and Clear Anodized. Custom colors available at an additional charge.
- 

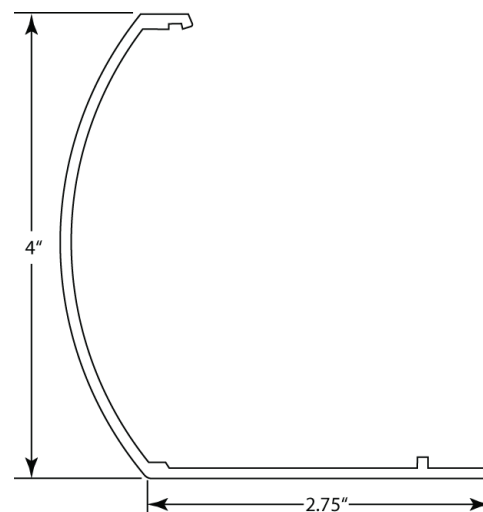

---

#### 3" & 4" Back Fascia

- A snap on aluminum fascia panel that covers the backside of the shade roll and mounting hardware.
- Available in 3" and 4" sizes to match 3" and 4" box brackets.
- Colors: White, Bone, Bronze, Black and Clear Anodized. Custom colors available at an additional charge.
- Available in contract quantities only

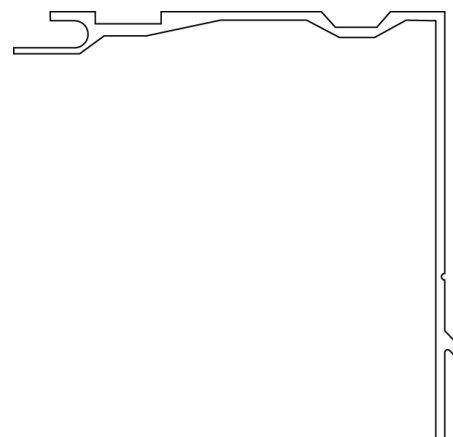

---

#### Dual Fascia

- A snap on dual aluminum fascia panel that covers the shade rolls and mounting hardware. It provides a sleek finished look. 5.5" x 7.25" box brackets mount to side, ceiling, or rear wall.
- Designed for the larger dual shades and thicker tube diameters, this fascia is for M24 Dual Manual Shades.
- Colors: White, Bone, Bronze, Black and Clear Anodized. Custom colors available at an additional charge.

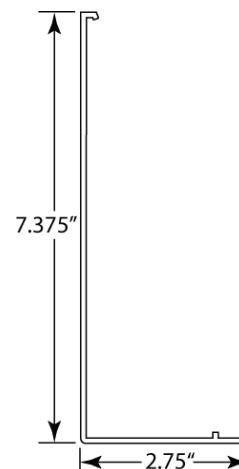

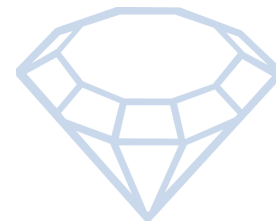

## ACCESSORY COMPONENTS – SIDE & SILL CHANNELS

### Single Side Channel and Sill Channel

- Side and Sill channels are used for installations needing complete blackout conditions.
- Our side and sill channel is a 2-piece snap fit design which can be mounted on the inside or face of a window mullion.
- Dimensions: 2.25" x 1"
- Standard finishes: white, bone, bronze, black, and clear anodized. Custom colors are available at an additional charge.

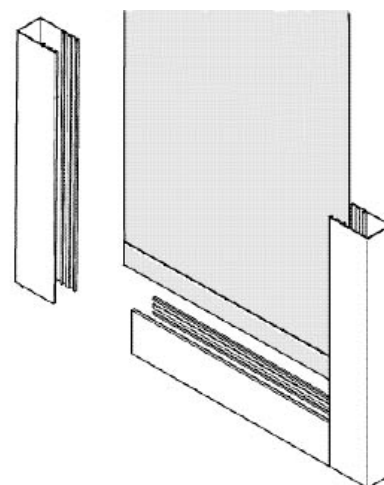
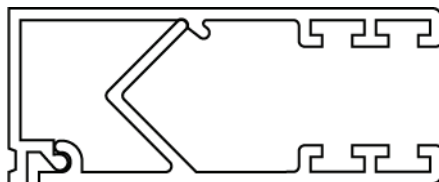

---

### Double Side Channel

- Standard double channel is simply 2 pieces of single channel (shown above) set back-to-back and riveted together creating a center channel 4.5" wide.
- Double side channel is a snap fit design and is used when there are 2 adjacent shades which need a blackout track.
- The back channel piece is mounted on the face of the window mullion and the front pieces are snapped onto the back channel.
- Standard finishes: white, bone, bronze, black, and clear anodized. Custom colors are available at an additional charge.

---

### Double Side Channel – Narrow

- 2 piece interlocking channel
- Dimensions 1.0625" x 3.25"
- Available in contract quantities only

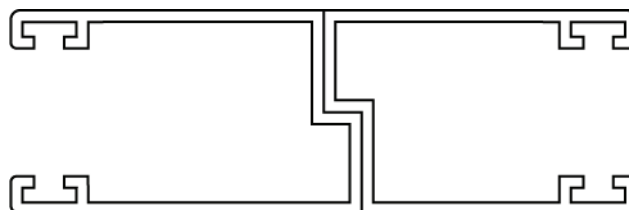

---

### Tile Clip Mount Strip

Tile clip mount strip mounts to inside front of pocket. 7/8" lip holds laying ceiling tile,

