

CUBICLE TRACKING ASSEMBLY INSTRUCTIONS

7000 SERIES

Ceiling Mounted

Cut track to length and attach end stops (use End Stops in pairs- one with a pull-out, and one without). Secure track to ceiling (see ceiling mount drawings). Once track is securely mounted, remove pull-out from end stop, insert the required number of carriers, and re-insert pull-out into the end stop. To install the cubicle curtain, carefully slide the grommets, located at the top of the cubicle curtain, over the hooks of the carriers.

For smoother operation, lightly spray the inside of the track with an aerosol silicone lubricant. Depending upon environment, clean and re-lubricate as necessary.

Suspension Mounted

Cut track to length and attach end stops (use End Stops in pairs- one with a pull-out, and one without). Attach suspension tubing ceiling brackets to the ceiling (see ceiling mount drawings) then, attach suspension tubing and track brackets. Position suspension tubing assemblies along path of the track at 24" to 36" intervals. Once the suspension tubing is securely mounted to the ceiling, attach the track to the suspension tubing. Once the track is secured, remove pull-out from end stop, insert the required number of carriers, and re-insert pull-out into the end stop. To install the cubicle curtain, carefully slide the grommets, located at the top of the cubicle curtain, over the hooks of the carriers.

For smoother operation, lightly spray the inside of the track with an aerosol silicone lubricant. Depending upon environment, clean and re-lubricate as necessary.

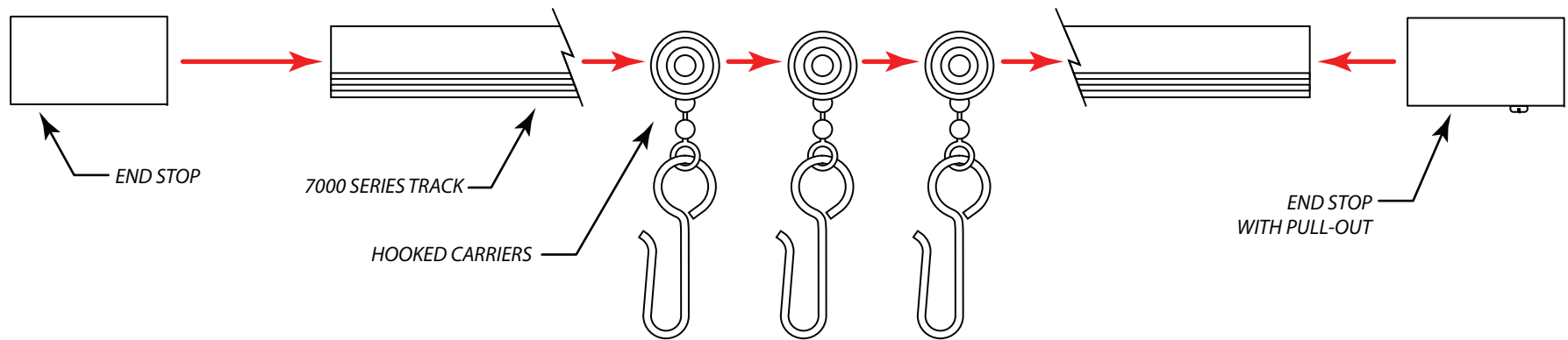

CONFIDENTIAL All materials disclosed in this document are proprietary to Diamond Drapery Co., Inc. The Holder agrees to maintain it in confidence and must not replicate or reveal this information in any manner.	Project: 7000 Series Tracking System Assembly		 7439 Lampson Avenue Garden Grove, CA 92841 (714) 761-4543 OFFICE (714) 761-4623 FAX
	Date: 17-DEC-2008	Dimensions: Inches/Feet	
	Scale: DO NOT SCALE	By: C. Johnson	

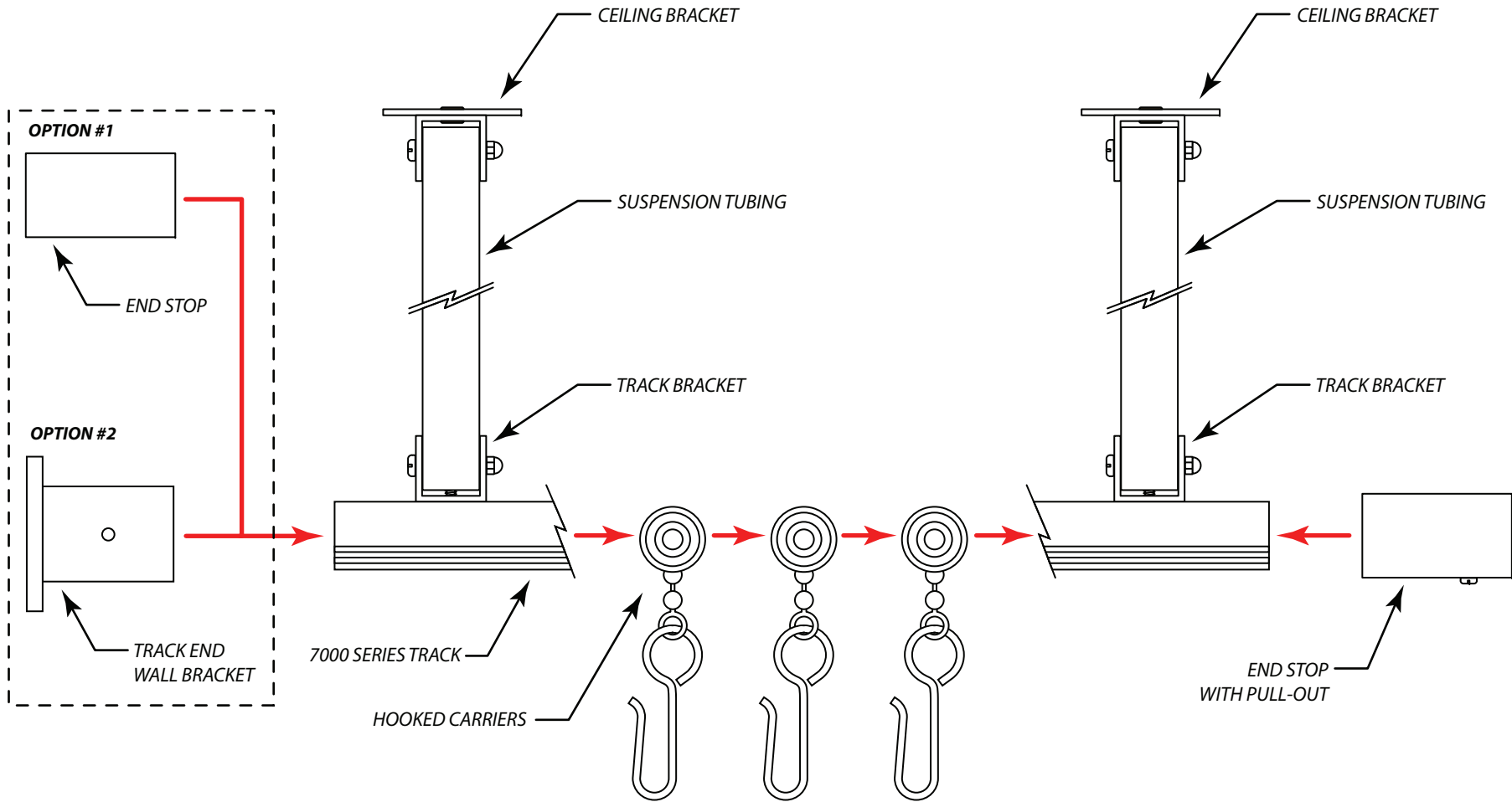

CONFIDENTIAL All materials disclosed in this document are proprietary to Diamond Drapery Co., Inc. The Holder agrees to maintain it in confidence and must not replicate or reveal this information in any manner.	Project: 7000 Series Suspended Tracking System Assembly	
	Date: 17-DEC-2008	Dimensions: Inches/Feet
	Scale: DO NOT SCALE	By: C. Johnson



7439 Lampson Avenue
 Garden Grove, CA 92841
 (714) 761-4543 OFFICE (714) 761-4623 FAX

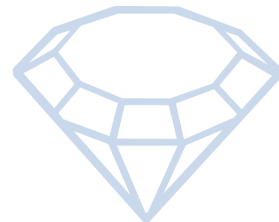

CUBICLE TRACKING ASSEMBLY INSTRUCTIONS

7000 SERIES – TRACK END WALL BRACKET

A track end wall bracket (part #7000-07) is used to attach the ends of suspension mounted tracks to the wall and acts as a closed end stop. This mounting greatly enhances the integrity of a suspension mounted cubicle tracking system.

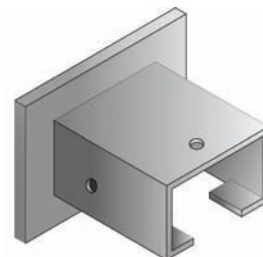

Instructions:

1. Once the suspended track system is in place, locate the track ends and mark their position on the wall. Loosen the track and swing it out of the way. Measure and attach the Wall Bracket to the wall using the appropriate mounting method (drywall & stud method illustrated here).

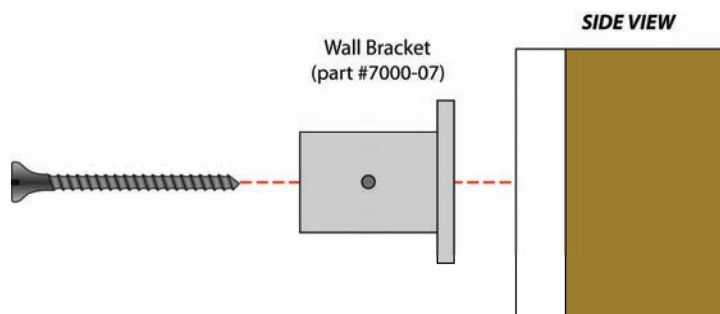

2. Slide the end of the track over the Wall Bracket.

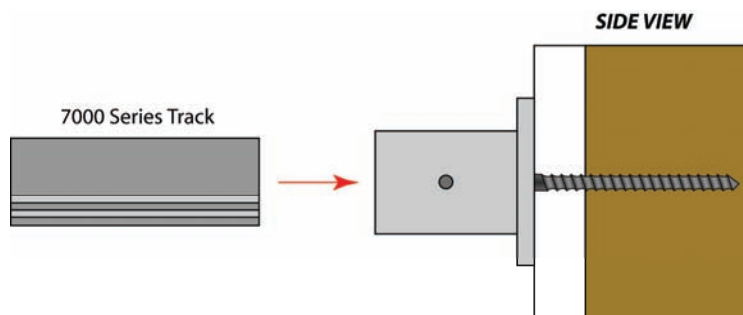

3. Secure track to the Wall Bracket using a two self-tapping screws inserted into the small holes on each side of the Wall Bracket.

