

End Stop
6000-03

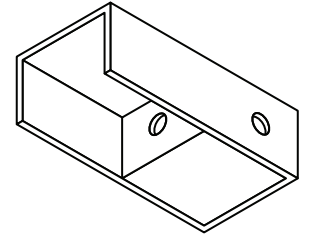

End Stop with Pull-Out
6000-04

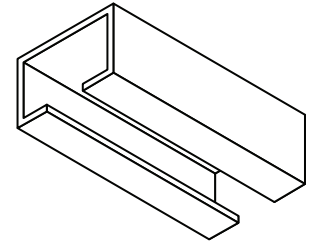

Splice
6000-05

Cubicle Track:

Diamond Drapery 6000 Series
Clear Anodized Aluminum

Carrier:

Diamond Drapery 6000 -01 Hooked Carrier
Celon body and wheels with nickel plated hook.

Other Parts:

Diamond Drapery endcap, endcap with pull-out, and splice. All clear anodized aluminum parts.

** Approximate distance from bottom of track to top of cubicle curtain. Distance may vary due to different fabric and mesh weights.

Stacking: Curtain stack depth is typically 1" for every foot of cubicle width. Depth may vary due to fabric type, mesh selection, and lining thickness (if selected).

Grommeting: Grommets are recommended to be spaced every 6" on-center.

<p>CONFIDENTIAL All materials disclosed in this document are proprietary to Diamond Drapery Co., Inc. The Holder agrees to maintain it in confidence and must not replicate or reveal this information in any manner.</p>	<p>Project: 6000 Series Cubicle Curtain Tracking System</p>	
	<p>Date: 23-DEC-2008</p>	<p>Dimensions: Inches/Feet</p>
	<p>Scale: DO NOT SCALE</p>	<p>By: C. Johnson</p>

DIAMOND DRAPERY
7439 Lampson Avenue
Garden Grove, CA 92841
(714) 761-4543 OFFICE (714) 761-4623 FAX

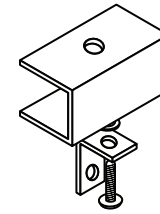
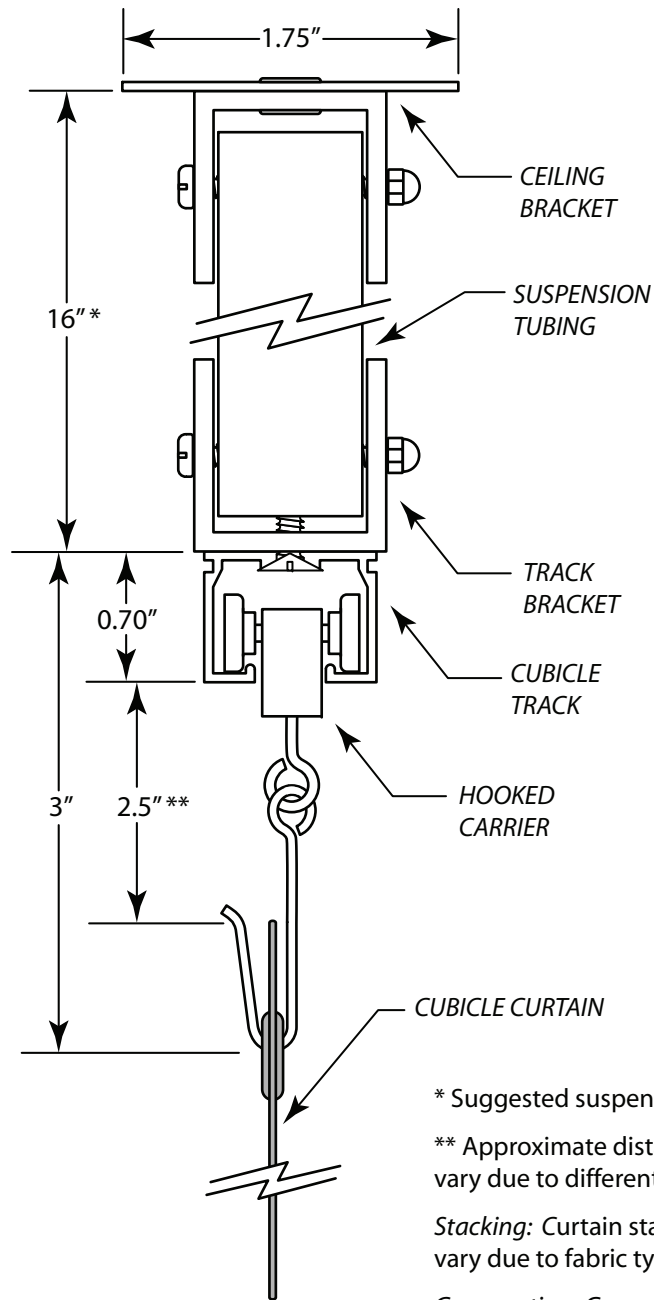

End Stop
6000-03

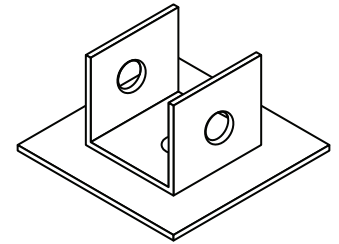

Ceiling Bracket
6000-06

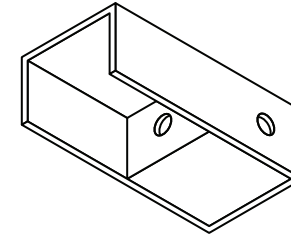

End Stop with Pull-Out
6000-04

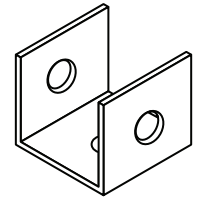

Track Bracket
6000-08

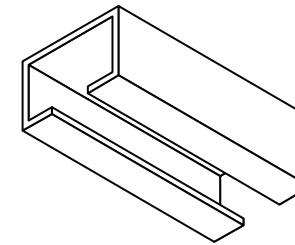

Splice
6000-05

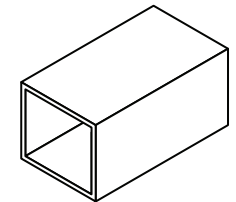

Suspension Tubing
6000-ST

OPTIONAL

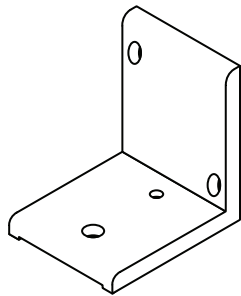

Track End Wall Bracket
6000-07

Cubicle Track:

Diamond Drapery 6000 Series
Clear Anodized Aluminum

Carrier:

Diamond Drapery 6000-01 Hooked Carrier
Celon body and wheels with nickel plated hook.

Other Parts:

Diamond Drapery end stop, end stop with pull-out, splice, ceiling bracket,
track bracket, and suspension tubing. All clear anodized aluminum parts.

* Suggested suspension length. Distance may vary due to site conditions.

** Approximate distance from bottom of track to top of cubicle curtain. Distance may vary due to different fabric weights.

Stacking: Curtain stack depth is typically 1" for every foot of cubicle width. Depth may vary due to fabric type, mesh selection, and lining thickness (if selected).

Grommeting: Grommets are recommended to be spaced every 6" on-center.

CONFIDENTIAL All materials disclosed in this document are proprietary to Diamond Drapery Co., Inc. The Holder agrees to maintain it in confidence and must not replicate or reveal this information in any manner.	Project: 6000 Series Suspended Cubicle Curtain Tracking System	
	Date: 23-DEC-2008	Dimensions: Inches/Feet
	Scale: DO NOT SCALE	By: C. Johnson

**DIAMOND
DRAPERY**

7439 Lampson Avenue
Garden Grove, CA 92841
(714) 761-4543 OFFICE (714) 761-4623 FAX